

Pushing and Braking Aid

v-max+

Translation of the original user's manual

GB



Ideen bewegen mehr

CE Declaration of conformity

The company AAT Alber Antriebstechnik GmbH herewith declares that the products of the power system v-max⁺ are developed and manufactured according to the general guidelines 2007/47/EG and 2006/42/EG of the European Union.

This declaration loses all validity, if the above mentioned devices have been tampered with or changed in any way without the knowledge and agreement of the company AAT Alber Antriebstechnik.



Signature of the manufacturer:



Markus Alber
Managing partner
AAT Alber Antriebstechnik GmbH



The power system v-max⁺ is being tested according to the norm DIN EN 12184 and DIN EN 12182 and at the institution for certification of medical products GmbH, Technical University Berlin.



AAT Alber Antriebstechnik GmbH

Postfach 10 05 60 · D-72426 Albstadt
Tel.: +49.74 31.12 95-0 · Fax.: 12 95 35
info@aat-online.de · www.aat-online.de

Table of contents

	CE Declaration of conformity	2
	Table of contents	3
1	General information.	5
1.1	How to use this user's manual	5
1.2	Instruction	5
1.3	Care and maintenance	5
1.4	Warranty and liability.	5
2	Description of the product.	6
2.1	Adequate use	6
2.2	General survey	7
2.3	Technical Data	9
2.4	Dimensioned sketch	10
2.5	Standard scope of delivery	11
2.6	Optional accessories	11
3	Assembly and initial operation.	12
3.1	Brackets	12
3.2	Mega battery pack	12
3.3	Hook on the v-max+	13
3.4	Detach the v-max+	15
3.5	Pushing and control grip	15
3.6	Functional check	17
4	Safety instructions and hazard notes.	18
4.1	Special information concerning the operation	18
4.2	Instruction	19
4.3	Operation / attendant.	20
4.4	Load	20
4.5	Care and maintenance	20
4.6	Conditions of paths, walkways etc.	20
4.7	Charge of batteries.	20
4.8	Power unit.	21
4.9	Transport	21
4.10	Mounting the brackets	21
4.11	Technical requirements	21
5	Operation	22
5.1	Maximm total weight.	22
5.2	Mega battery pack	22
6	Control and display elements	23
6.1	Control unit	23
6.2	On/Off push button.	24
6.3	Charge condition of the mega battery pack	25
6.4	Control light to indicate malfunction	26
6.5	Trouble shooting.	27
6.6	Transport	27
7	Accessories	28
7.1	Mega battery pack	28
7.2	Voltage converter for your vehicle	28



8	Care, maintenance and recycling	29
8.1	New user	29
8.2	Charger	29
8.3	Mega battery pack	31
8.4	Fuse	33
8.5	Cleaning	33
8.6	Recycling	33
9	Warranty and liability	34
9.1	Warranty	34
9.2	Liability	34

1 General information

Congratulations! You acquired a pushing and braking aid, operated by an assistant which can be adapted to almost any type of heavy-duty wheelchair by a special holding device.

v-max⁺ assists the attendant to push and brake the wheelchair. It facilitates the driving up of slopes and brakes automatically when going downhill thus providing extra safety for both the assistant and the wheelchair user.

With the v-max⁺ you can transport a person safely and without great physical effort up a maximum slope of 12 %. The v-max⁺ is also suitable to transport a person on level ground. The device is compact, light-weight and manoeuvrable.

The v-max⁺ is dedicated for the Type Class A and B according to the norm 12184.

The sticker with the device's serial number is located at the bottom side of the housing.

1.1 How to use this user's manual

The user's manual is part of the delivery package and instruct you step by step about the safe and adequate use of the v-max⁺. Operating the v-max⁺ takes a certain skill.

Please read this user's manual carefully and particularly take note of the safety instructions before you use the v-max⁺ for the first time.

After reading, please store this user's manual at an appropriate place for further reference.

1.2 Instruction

In the interest of your safety the v-max⁺ may only be operated by trained personnel.

Instruction on how to operate the device is part of the delivery package and takes place with your authorized dealer or an AAT representative.

Please read this user's manual carefully and particularly take note of the safety instructions before you use the movilino for the first time.

1.3 Care and maintenance

One of the most important aspects concerning the maintenance of the v-max⁺ is charging the seal lead acid batteries. They are part of the battery pack and must be charged every time after using the device.

Other than that your v-max⁺ does not need much care or maintenance. More extensive instructions you find in chapter 8.

1.4 Warranty and liability

For damage that was caused by inadequate use disregarding this manual we assume no liability whatsoever. (Please read chapter 9 for more detailed information concerning warranty and liability).

2 Description of the product

2.1 Adequate use

Please use the braking and pushing aid exclusively for the transportation of physically disabled persons.

Said person should be able to sit properly without help, otherwise you should secure them with a safety belt. The latter is an accessory available at AAT Alber Antriebstechnik GmbH.

In addition, the arms of the person to be transported should not protrude over the arm rests of the wheelchair during the transportation process.

- ☞ In the interest of your safety you may not use the v-max⁺ on escalators or moving belts!
- ☞ Transporting other kinds of loads is explicitly prohibited!
- ☞ Only authorized operators may use the v-max⁺. Therefore never leave the v-max⁺ unattended.
- ☞ Due to safety reasons the v-max⁺ may only be operated by trained personnel who are physically and intellectually capable to handle the device in all situations of operation.
- ☞ Please note the wheelchair manufacturer's specifications (wheels' air pressure, maximum approved total weight, maximum incline, etc.) when using the v-max⁺. You may under no circumstances exceed the specified limiting values!
- ☞ Please avoid driving on unpaved or unfortified grounds such as sand, mud, loose gravel, ice or snow.

2.2 General survey

- ❶ = control grip
- ❷ = v-max⁺ power unit
- ❸ = heavy-duty wheels incl. handrim and toothed ring
- ❹ = brackets on the wheelchair
- ❺ = mega battery pack incl. bag
- ❻ = pushing grip



2.2.1 Control grip

- ❶ = speed control
- ❷ = rocker switch backwards/forwards
- ❸ = link to hold grips
- ❹ = helix cable

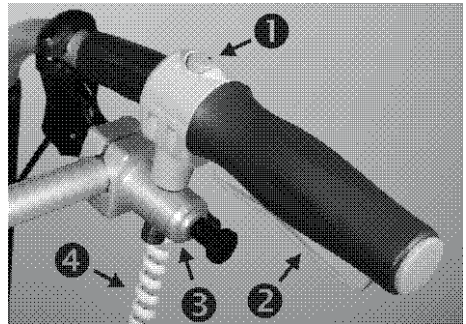

2.2.2 Power unit

- ❶ = control grip
- ❷ = power switch
- ❸ = driving unit's link to the wheelchair
- ❹ = mega battery pack
- ❺ = socket for power cable (out) and charging cable (in)
- ❻ = socket for power cable on the v-max⁺
- ❼ = control panel

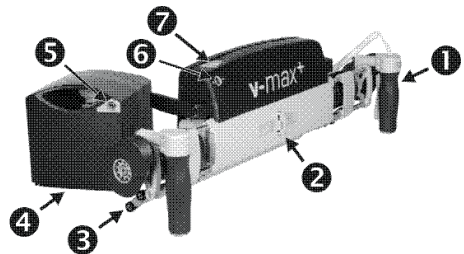

2.2.3 Control panel

- ❶ = push button On/Off
- ❷ = indicator of battery charge and malfunction

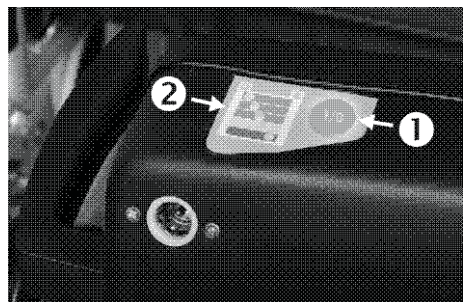

2.3 Technical data

Measurements	height = 275 mm width = 630 mm depth = 185 mm
Weight	power unit incl. handle = 13,5 kg mega battery pack = 14,3 kg power cable = 0,2 kg bag for batteries incl. velcro straps = 0,3 kg charger = 0,3 kg total weight = 28,6 kg
Limits for mounting the v-max ⁺ on a wheelchair	seat width of 60 cm and more
Max. approved total weight	300 kg (person, wheelchair, v-max ⁺)*
Speed	continually adjustable 5,5 km / h forward 3 km / h backward
Max. slope	up to 12 %**
Capacity with one battery charge	up to 22 km**
Batteries	2 x 12 V / 22 Ah
Direct current motor	24 V / 419 W
Storing an operating temperature	- 20° C to + 60° C / - 10° C to + 50° C
Noise level	The device's A weighted noise level lies typically below 60 dB
Vibration specifications	The weighted RMS value of acceleration the upper body is exposed to lies typically below 2,5 m/s ²

* Limiting values stipulated by the wheelchair manufacturers must be noted and observed.

** Range and climbing potential depends, among other factors, on the weight of the person to be transported, the road conditions, the territory, etc.

In the interest of progress we reserve the right for technical changes.

2.4 Dimensioned sketch

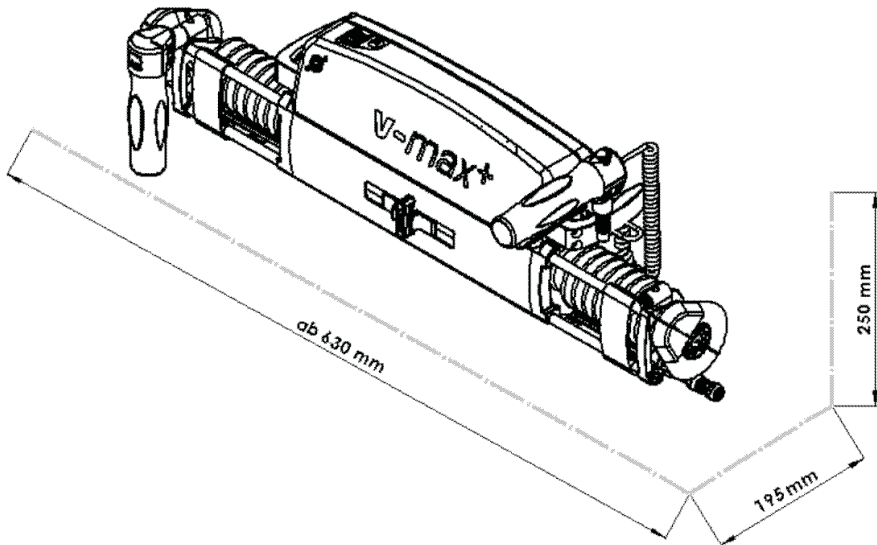

2.5 Standard scope of delivery

The following is part of the standard scope of delivery:

- ❶ = heavy duty wheel incl. handrim and toothed ring
- ❷ = v-max⁺ power unit plus handle
- ❸ = charger incl. user's manual
- ❹ = mega battery pack incl. bag

...as well as the components mounted to the wheelchair, power cable and bag for the battery pack plus the user's manual (no picture).

In addition, it is necessary to mount brackets to the wheelchair. (this is not included in the delivery package).

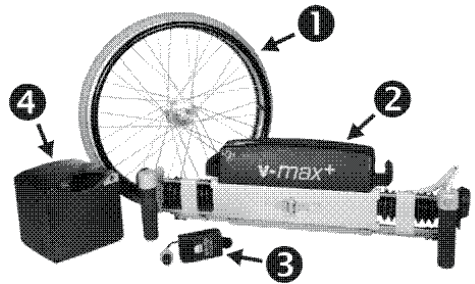

2.6 Optional accessories

- ❶ = spokes' protection
- ❷ = voltage converter
- ❸ = hip belt
- ❹ = anti tilt support



1



2



3



4

3 Assembly and initial operation

The v-max+ can only be used in connection with a special bracket which must be mounted to your wheelchair.

This bracket may only be mounted by AAT or dealers authorized by AAT.

3.1 Brackets

All brackets are especially developed and adjusted to each individual wheelchair, which means that the bracket, ❶ right and ❷ left, pictured in this operator's manual may differ from the one attached to your wheelchair.

- ☞ Before each use, check whether the bracket is securely fastened to the wheelchair. In case screws have loosened or fallen out you may not use the v-max+. Please contact your dealer immediately.
- ☞ Please note that mounting the v-max+ to a wheelchair (depending on the model) may result in restricting the adjustment of its seat or back rest.
- ☞ Mounting the v-max+ to a wheelchair (depending on the model) may result in a change of the wheelchair's measurements.

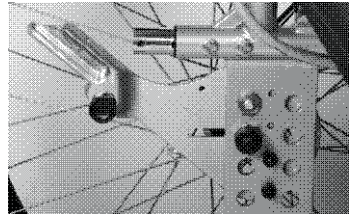
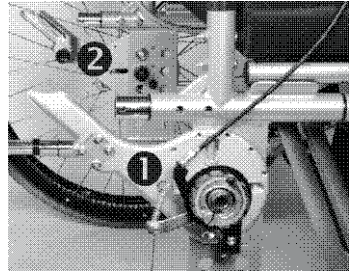

3.1.1 Attach and detach the wheels

Full-floating axles: with your index finger press the locking bolt in the middle of the axle to release the connection and the wheel can be taken off.

Instantaneous axis: remove the cover and loosen the nut with a flat wrench. Now pull the instantaneous axis through the opening and take off the wheel.

Always remove first one and then the other wheelchair wheel.

To mount the wheels on the wheelchair, please follow these instructions in reverse order.

3.2 Mega battery pack

A bag for the battery pack is attached under the seat of the wheelchair.

Simply slide the mega battery pack into its bag

and fix it with a velcro strap.

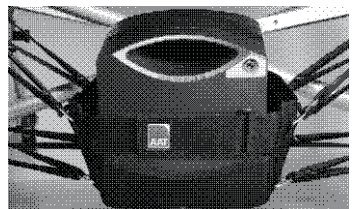
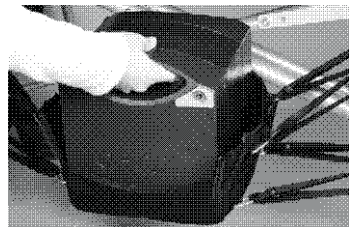

3.3 Hook on the v-max⁺

To mount the v-max⁺ the powered axles must be inserted entirely. Press the two slide switch **1** toward the PRESS button **2** until they lock. See picture on the right.

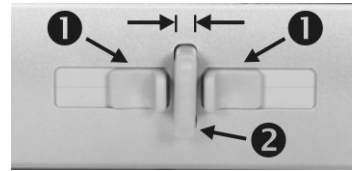

Now slide the v-max⁺ evenly, on both sides, into the brackets.



☞ Make sure the v-max⁺ with its wheelchair links **1** is in a straight line when you insert it into the brackets **2**.

Then the v-max⁺ slides automatically **3** into the appropriate place in the brackets.

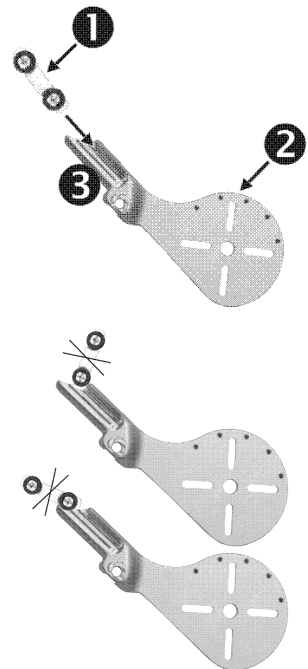

Now you press the PRESS button to unlock the levers and the powered axles come out.



☞ The power unit is activated, if both slide switch ❶ have reached their outer position.

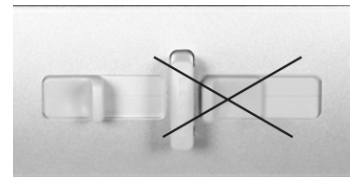
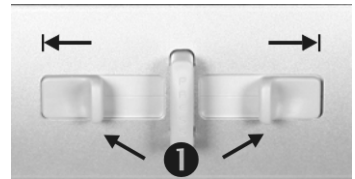

☞ The driving unit locked properly, if the wheelchair cannot be moved manually any more.

Now you can insert the plug ❶ of the power cable into its socket ❷ on the v-max⁺.

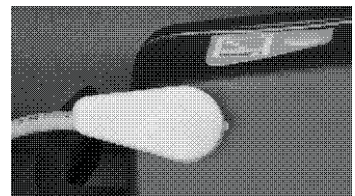

Then you put the other plug **1** of the power cable into its socket **2** on the mega battery pack.

☞ Please make sure that the power cable's plug is dry and clean.

If the device is already attached to the wheelchair (as described in chapter 3.3), the v-max⁺ is now ready to use.

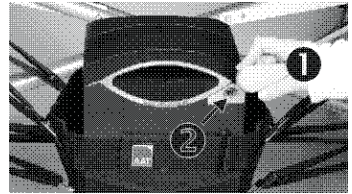

3.4 Detach the v-max⁺

To detach the v-max⁺, please follow these instructions (chapter 3.3 – 3.4) in reverse order.

☞ Please remove the power cable plugged into the jack of the v-max⁺ first.

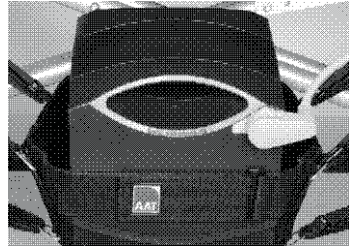

3.5 Pushing and control grip

The wheelchair driver's attendant controls all functions of the v-max⁺ by means of the control grip. Since the control grip **1** and the pushing grip **2** can be installed either on the right or the left side, the v-max⁺ is ideal for both right-handed or left-handed users.

At the ends of the regular wheelchair grips receptacles **3** are attached into which you can stick both grips of the v-max⁺ on either side. These particular grip holders allow the user to insert either one of the grips in various positions on the right or the left side, so an individual and comfortable adjustments of the grips is possible.

☞ Please make sure that the grips are locked firmly on the receptacles!

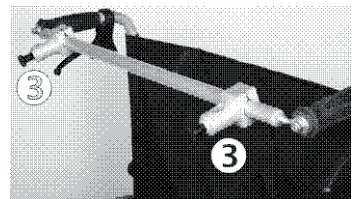

3.5.1 Attaching the grips

Due to the special tothing (see picture) it is possible to insert the grips into the receptacles in the most comfortable position for each individual users.

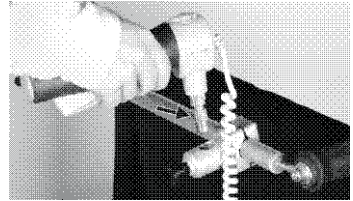

See picture on the right indicating the grip positions which have proven most comfortable for frequent use.



3.5.2 Removal of the grip

Pull the locating pin ❶. The grip ❷ unlocks and you can lift it out of the link.

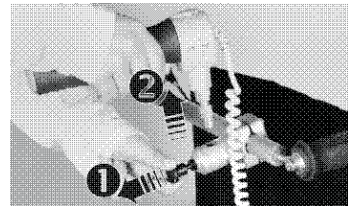

In case you do not need the device for some time, simply remove the grips and put them back into their respective holders on the v-max⁺ (see picture).

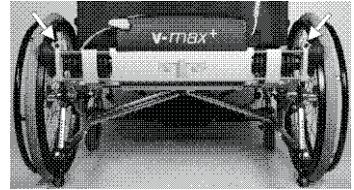

This way the grips turn into stable feet for the v-max⁺ so you can simply set it aside.



3.6 Functional check

- ☞ Please check the device's electronic functions each time before using it (see chapter 6.1)!
- ☞ Make sure that the mega battery pack is charged before you use the v-max⁺!
- ☞ Please make sure that the tilt support is not jammed whenever you use the v-max⁺!

4 Safety instructions and hazard notes

☞ For a safe operation of the v-max⁺ it is important that you observe and adhere to all warning signs and instructions in this user's manual as well as the warning signs and instructions on the device itself.

All general rules for the safe use of a wheelchair apply without reservation while operating the v-max⁺. You must always observe the limit values and instructions indicated by the manufacturer (e.g. air pressure, maximum total weight, maximum inclination, etc.).

☞ Limit values may never be exceeded!

To assure a safe use of the v-max⁺, it is indispensable to observe the following directions:

4.1 Special information concerning the operation:

Generally all of the wheelchair's specific limiting values indicated by the manufacturer must be observed.

In the interest of your safety the pushing and braking aid v-max⁺ may not be used on escalators, stairs, moving walkways or unfortified surfaces. You may only move the wheelchair plus mounted v-max⁺ manually (see chapter 3.3), if the device is turned off. Please observe the instructions and limiting values of your wheelchair's manufacturer.

Please first get familiar with the handling characteristics and riding qualities of the device. Please drive first on level ground until you feel comfortable in handling the v-max⁺ safely. Practise at a low speed.

☞ Always turn the speed control to its lowest speed when you begin using the device and increase the speed slowly to the desired tempo.

☞ Please lower the speed before driving down an incline.

☞ Please do not roll down an incline with the v-max⁺ disengaged!

Even though the v-max⁺ manages inclines up to 12%, the wheelchair manufacturer's stipulated maximum incline may under no circumstances be exceeded. (Ramps in public buildings have an incline of approximately 6 %.)

☞ Please cross over obstacles such as curbs on sidewalks with a turned off v-max⁺. Crossing over higher curbs should be done backwards because the rollers may jackknife. Please pull the wheelchair at its grips not at the ones of the v-max⁺. Also always check the height of your anti-tilt support and keep in mind the wheelchair manufacturer's stipulated maximum height.

The current road traffic regulations apply when you use the v-max⁺ on public roads. Should there be additional devices necessary, you need to mount them to your wheelchair as soon as possible. In such case, please contact your local dealer.

Please avoid driving parallel on steep slopes to avoid a tilting over sideways of your wheelchair. Always counter-steer when the curb on the sidewalk is slanting downward and remain at a safe distance to the curb.

Please do not drive to the edge of stairs or precipices with the v-max⁺ turned on.

☞ Please do not attach anything to the v-max⁺'s grip!

Please check the wheelchair's anti-tilt support before each use. Please do not drive backwards against a wall with mounted anti-tilt support because they could jam and thus not function properly.

When you use mass transportation such as bus, subway, tram, etc.) please turn off the v-max⁺ and use the locking brakes on your wheelchair.

Please cross streets, intersections and railway crossings paying extra attention.

Please never cross rails (e.g. railway tracks) in a parallel way because the wheels could be jammed.

If the v-max⁺ is turned off you cannot move the wheelchair manually any more, i.e. the engine is blocked. However, there is one exception: due to the mechanical locking mechanism of the engine's sliders the v-max⁺ is disengaged. Now you can move the wheelchair (see chapter 3.3). The brake effect is only there when the device is turned on.

- ☞ The v-max⁺ can always be stopped - during regular use or in an emergency - by pushing and releasing of the panic switch. Further information on the panic switch you find in chapter 6.1.3
- ☞ In case of malfunction, please follow the instructions in chapter 6.5 Troubleshooting.

4.1.1 Environmental conditions, electro-magnetic compatibility

Electro-magnetic compatibility means that an electric device functions properly in its electro-magnetic environment without influencing other devices in the same environment.

The v-max⁺ successfully passed all the EMV tests required by law. Nevertheless, always check whether the device's electronic functions work properly before each use. This is particularly important if there is an aerial mast nearby.

- ☞ Please note that the v-max⁺ may interfere with other electronic devices' sensitive electro-magnetic fields (e.g. anti-theft systems in department stores). This may also happen if you connect other devices.

Also make sure that the v-max⁺ is not operated in close proximity to medical devices with a high potential for danger and/or life-supporting functions as well as diagnostic devices.

4.1.2 Climate

To ensure proper functioning it is not advisable to expose the v-max⁺ to freezing conditions. Should this be unavoidable, always put the device in a non-freezing environment for at least one hour before using it (see chapter 2.3)

At this point check the device before operation. Should your v-max⁺ not function properly, please call your local dealer or AAT directly.

Please note that the surface temperature of the v-max⁺ could be increased due to the influence of external heat sources like sunlight.

4.2 Instruction

In the interest of your safety the v-max⁺ may only be operated by people instructed in the use of the device and further by people who are physically and mentally capable to manage the v-max⁺ in all situations that may occur while using it.

4.3 Operation / attendant

Thorough instruction into the use of the v-max⁺ by your dealer or a representative of AAT Alber Antriebstechnik is part of the delivery package and takes place at an appointment of your choice. This is a free service at no extra charge.

☞ Do not use the v-max⁺ without being trained to operate it.

Anti-tilt supports are obligatory.

Should you feel insecure handling the v-max⁺, please contact AAT Alber Antriebstechnik GmbH or your authorized dealer.

4.4 Load

The maximum total weight of 300 kg is composed of the weight of the person to be transported plus the weight of the wheelchair and the v-max⁺.

☞ This weight may under no circumstances be exceeded!

☞ Please use the v-max⁺ exclusively to transport people!

☞ It is strictly prohibited to transport goods with the device.

4.5 Care and maintenance

Please make sure that you charge the battery pack after each use of the v-max⁺. If the v-max⁺ is not in operation, please turn off the device.

If the working elements of the device block, turn the v-max⁺ off immediately.

☞ Repairs may be done by authorized dealers or the manufacturer only.
Please exclusively use AAT Alber parts and accessories.

Please note the extensive care and maintenance instructions in chapter 8.

4.6 Condition of paths, walkways etc

Avoid driving with the v-max⁺ on unfortified paths such as sand, mud, loose gravel, ice or snow.

Please avoid using the v-max⁺ in the rain, ice, snow or general wet conditions because then the wheels' grip on the ground is reduced. There is an increased danger of slipping and sliding. Please adjust your driving style accordingly.

4.6.1 Environmental conditions

Although the v-max⁺ has been tested for its electro-magnetic compatibility, you should still check its electronic functions before each use. This is particularly important if there is an aerial mast nearby.

4.7 Charge of the batteries

☞ You should only use the v-max⁺ with fully charged batteries. The light emitting diode indicates the state of the batteries' capacity.

☞ Please be careful when going downhill with full batteries. The drive down generates electricity which charges the batteries additionally. This may lead to excess voltage which in turn may lead to a turning off of the v-max⁺. During regular use the device reduces its speed automatically to avoid overvoltage.

☞ When going uphill it is also possible that the device turns itself off. This can happen if there is excess temperature (see chapter 6.5)

4.8 Power unit

The v-max⁺ plus its power unit is for the most part covered by the housing. Nevertheless, please make sure that while driving you do not put fingers or hands into the rotating area (e.g. chain wheel or driving pinion). Always keep a safe distance.

4.9 Transport

For transportation you can remove the v-max⁺ from its brackets (see also chapter 3.3 hook on the v-max⁺). Carry the device at its designated grips.

- ☞ Before using mass transportation (e.g. bus, tram, subway, etc.) or a car, you should remove the v-max⁺ from the wheelchair!
- ☞ For transportation, please always turn off the v-max⁺!
- ☞ When you transport the device in vehicles, please secure it according to the relevant legal regulations in your country.
- ☞ The sealed lead acid batteries used in the v-max⁺ are not considered dangerous according to the IATA special guidelines A67 and GGVS Rn-Nr. 2801 A, section 2, and admitted to air travel by DOT and IATA.

4.10 Mounting the brackets

Attaching the v-max⁺'s brackets to the wheelchair or making changes on said brackets may only be performed by the company AAT Alber Antriebs-technik or their authorized dealers.

The v-max⁺ may only be attached to wheelchairs which must be checked according to generally acknowledged technical norms, and their operator's manuals must be applied when using the v-max⁺.

Before each use please check all the holding devices and attachments. Also make sure that the device itself functions properly. Should anything not work you may not use the v-max⁺. In that event, please contact your local dealer.

4.11 Technical requirements

When using the v-max⁺ all indicated limiting values, such as maximum incline or approved maximum load, stipulated by the wheelchair manufacturer must be observed.

- ☞ Indicated limiting values may never be exceeded.

Please always check the air pressure of pneumatic steering rollers. The v-max⁺ driving qualities could be affected negatively, if there is not enough air in the rollers.

The air pressure in the wheelchair's wheels must correspond to the wheelchair manufacturer's stipulations.

It is compulsory to use anti-tilt support on the wheelchair. Please check those before each use. Make sure that they are not jammed. Also never drive backwards all the way to a wall with mounted anti-tilt support.



5 Operation

5.1 Maximum total weight

Please note that the maximum total weight of 300 kg (wheelchair, person and v-max⁺) is not exceeded.

5.2 Mega battery pack

Please make sure that the batteries are fully charged before you use the v-max⁺ for the first time (extensive instructions you find in chapter 8.3)

6 Control and display elements

Before we get to the actual instructions for operation, we would like to introduce the v-max+'s most important components to you.

Your v-max+ was prepared for you by AAT or your dealer so that when the device is properly mounted, locked and connected, it is ready to use as soon as you turn it on.

Please familiarize yourself with the device at first with an empty wheelchair to acquire a feeling for its functions as well as the panic switch.

6.1 Control unit

The wheelchair driver's attendant controls all of the v-max+'s functions by means of the control unit.

6.1.1 Speed control

The speed control ❶ allows you to pre-select speed.

☞ Turn the speed control counter-clockwise all the way for minimum speed.

You must begin with minimum speed when you use the v-max+ for the first time.

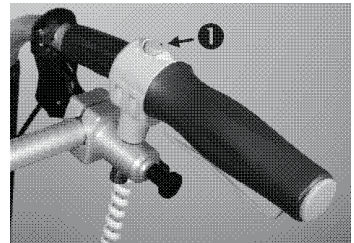

6.1.2 Rocker switch

With the rocker switch you determine the direction and speed (up to the pre-selected speed) of the v-max+.

☞ Use the rocker switch carefully.

To drive forward you press the longer back part of the rocker switch ❷. To drive backward, please press the rocker switch's shorter front part ❸.

The v-max+ speeds up the more you press the rocker switch until you reach the maximum pressure point. It slows down the more you release the rocker switch.

If you release the rocker switch entirely while driving, the power unit brakes until the wheelchair comes to a standstill. To increase the braking effect, the power unit reverses the polarity.

Two seconds after standstill is reached, an electro-magnetic parking brake becomes active.

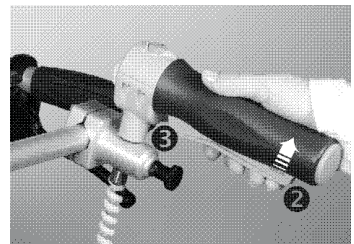

6.1.3 Panic switch

If during an emergency you press the rocker switch too hard so that the pressure point is overcome, the so-called panic switch causes the v-max⁺ to go from driving mode into coast. As long as you keep the rocker switch pressed, you can drive the patient away from the dangerous situation.

However, as soon as you release the rocker switch the electromagnetic brake is activated.

Depending on particular circumstances the electro-magnetic brakes' strong effect may brake the wheelchair so abruptly that it stops immediately.

The panic switch works both ways going backward and forward as well as during malfunction (please see chapter 6.4 for trouble shooting).

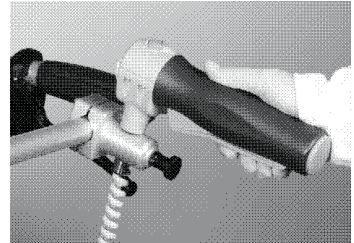

6.2 On/Off push button

The push button is located on the power unit and marked "1/0". You turn On/Off the device by pressing the key.

If the device has not been used for longer than 5 minutes, it turns itself off automatically. In such case, please press the push button again and the v-max⁺ is ready to use once more.



6.3 Charge condition of the mega battery pack

A number of light emitting diodes inform you about the batteries' charge. They are located on the power unit next to the On/Off push button.

The light emitting diodes and their meaning:

The diode lights up in -

- the first green bar: mega battery pack is 100 % charged
- the second green bar: mega battery pack is 80 % charged
- the third green bar: mega battery pack is 60 % charged
- the yellow bar: mega battery pack is 40 % charged
- red bar: mega battery pack is 20 % charged

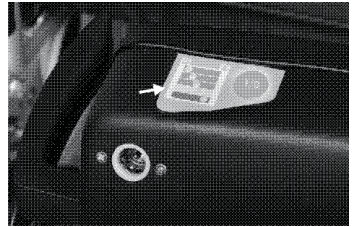

☞ If the diode lights up in the red bar, you must charge the mega battery pack immediately.

Due to the extensive self tests of the electronics, it is possible that the charge indication only shows 80 %, even though the batteries are full. Please wait approximately one minute, then the charge will be indicated correctly.

Due to the batteries and the data recorder, the charge's condition is only then properly indicated if the rocker switch is in a neutral position. So if the rocker switch is not pressed, it may take up to one minute until there is a change in the batteries' display.

6.4 Control light to indicate malfunction

Malfunction is indicated by blinking of the red light emitting diode on the control panel. In case of malfunction, please first turn off the device and then on again. Should the device still indicate a malfunction, charge the mega battery pack in case of low voltage.

Red diode is blinking	Malfunction
1 x	Motorcontroller, motor oder mega battery pack defective
2 x	low voltage, battery is empty
3 x	overvoltage
4 x	electro-magnetic brake at fault
5 x	indicator for excess voltage
6 x	indicator for overstressing
7 x	indicator for excess temperature

In cases of malfunction such as the blinking of 1 – 4 times we consciously abstained from automatically activating the electro-magnetic brakes as soon as the malfunction is recognized while the device is driving.

☞ If you want to activate the electro-magnetic brake, push the rocker switch hard to overcome the pressure point and the panic switch is activated. Then release the rocker switch.

In all other cases of malfunction the electro-magnetic brake is automatically activated.

Caution: Should the display blink red 7 times (overheating) then one has to wait for approximately 5 minutes, depending on the temperature.

☞ In this condition the device cannot be activated by first switching it off and then on again.

☞ Should you have to move the wheelchair and the device is in said condition of malfunction, you may only do so by mechanically locking the slide switches of the power unit (see chapter 3.3) .

☞ After the device cooled down it turns itself back on automatically.

For all other cases of malfunction, please contact your dealer.

6.5 Trouble shooting

If there are problems using the v-max⁺ please check the following trouble shooting chart and see whether you cannot fix them yourself.

Problem	Check and potential solution
v-max ⁺ cannot be turned off	Is the charger connected to the v-max ⁺ ? If so, disconnect the charging cable and plug in the power cable
	Is the mega battery pack empty? If so, charge the batteries.
	Are the fuses damaged? If so, exchange the fuses.
	If there is still a problem turning on the v-max ⁺ , please contact your dealer.
Batteries don't charge	Please contact your dealer.

6.6 Transport

For transportation you can remove the v-max⁺ from its brackets (see also chapter 3.3 hook on the v-max⁺). Carry the device at its designated grips. (see picture).

- ☞ Note that the device weighs 13,5 kg!
- ☞ Always turn off the v-max⁺ for transportation!
- ☞ When transporting the v-max⁺ in a vehicle, always secure the device according to the legal rules and regulations.
- ☞ The sealed lead acid batteries used in the v-max⁺ are not considered dangerous according to the IATA special guidelines A67 and GGVS Rn-Nr. 2801 A, section 2, and admitted to air travel by DOT and IATA.
- ☞ Before using mass transportation such as buses or subways, etc. or your personal vehicle, please detach the v-max⁺ from you wheelchair!



7 Accessories

7.1 Mega battery pack

The v-max+ is delivered with one mega battery pack with charging electronics.

If you use the v-max+ often, i.e. if there are not sufficient breaks for the batteries to be recharged, we recommend you obtain an additional mega battery pack (available as an accessory). In such case one mega battery pack is in use while the other is being recharged at the same time.

- ☞ If you do not use the v-max+ both battery packs should be connected to the charger to increase their durability (see chapter 8.3).
- ☞ Please exclusively use the AAT Alber Antriebstechnik GmbH charger to charge your mega battery pack.



7.1.1 Exchange the mega battery pack

1. Turn off the v-max+ with the On/Off push button.
2. First remove the power cable from its socket on the v-max+. Afterwards remove the plug of the power cable from the socket on the mega battery pack.
3. Please open the velcro strip of the bag and take out the mega battery pack.

- ☞ The mega battery pack should always be connected to the charger to extend its durability (see chapter 8.3).
- ☞ Please exclusively use the AAT Alber Antriebstechnik GmbH charger to charge your mega battery pack.

The mega battery pack of the v-max+ is maintenance-free and rechargeable. Its durability depends directly on the number of charging/discharging cycles.

7.2 Voltage converter for your vehicle

We recommend the voltage converter for your vehicle, if you transport the v-max+ in your car. The AAT voltage converter is designed for a 12 V electrical system. This voltage converter transforms 12 V / 24 V direct current (D.C.) into 230 V alternating current (A.C.).

The plug of the voltage converter ❶ is plugged into the cigarette lighter in your car or into the socket of the supply system. The automatic charger's 230 V connector ❷ is plugged into the socket of the converter.

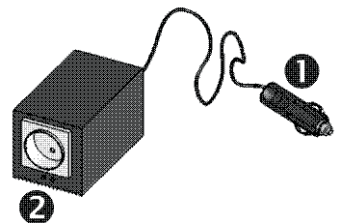

8 Care, maintenance and recycling

To ensure the v-max+'s safe and proper functioning we recommend a safety check done on the device every two years, even though there might not be any outer damage or malfunction evident.

☞ For safety reasons this safety check or repairs of any sort may only be performed by AAT Alber Antriebstechnik or the authorized dealer.

The device itself does not call for particular maintenance or care except for the occasional cleaning (see chapter 8.5).

8.1 New user

If the device goes to a new user, we recommend a safety check.

8.2 Charger

Please exclusively use the AAT Alber Antriebstechnik GmbH charger to charge your mega battery packs.

8.2.1 Automatic charger

The charger does not need any particular maintenance. The scope of delivery includes the AAT Alber Antriebstechnik GmbH charger. Plug ❶ is inserted into the wall outlet and plug ❷ into the socket on the device or the mega battery pack.

This automatic charger recharges your batteries 100%. As soon as the charging process is completed, it switches to a retaining mode, thus overcharging is impossible.

- ☞ Before using the charger, please read and follow all instructions and warning notes included with the charger.
- ☞ Exclusively use the AAT charger to charge the batteries.
- ☞ Check the charger regularly and protect it from oils, grease, aggressive cleaning agents, thinners and/or damage by sharp edges, etc.
- ☞ Repairs and service check-ups may only be performed by AAT Alber Antriebstechnik GmbH or their authorized personnel.
- ☞ Please do not disassemble or modify the charger!
- ☞ Please make sure that the charger is not exposed to dampness or humidity while charging the batteries.
- ☞ Never touch the plug with moist hands!

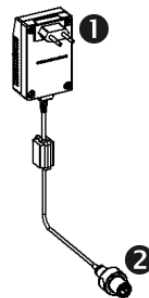

8.2.2 Voltage converter for your vehicle

The voltage converter does not need particular care or maintenance. Nevertheless, check your voltage converter regularly and protect it from oil, grease, aggressive cleaners, diluting agents and/or damage due to sharp edges, etc.

- ☞ Before using the voltage converter, please read and follow all instructions and warning notes printed on the voltage converter.
- ☞ Exclusively use the AAT Alber Antriebstechnik GmbH voltage converter!
- ☞ Check the voltage converter regularly and protect it from oil, grease, aggressive cleaning agents, thinners and/or damage by sharp edges, etc.
- ☞ Repairs and service check-ups may only be performed by AAT Alber Antriebstechnik GmbH or their authorized personnel.

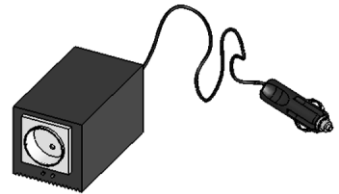

8.3 Mega battery pack

The mega battery pack's sealed lead acid batteries should be recharged after each use. They are air-tight, maintenance-free, rechargeable and of excellent quality.

The mega battery pack undergoes a so-called self-discharge; therefore, you should connect your mega battery pack, whenever possible, to a charger. The charging automatism, which switches from charging the battery to retaining the charge when it is full, kicks in and keeps the battery from overcharging.

If you take good care of your mega battery pack by recharging it regularly, you prolong its durability. The v-max⁺'s electronics constantly check the battery's charge and thus prevent a total discharge, if used adequately.

☞ Avoid a total discharge of the mega battery pack. Recharge it after each partial discharge, i.e. after each use of the v-max⁺.

☞ Charging your batteries is taking good care of them!

If your mega battery pack has not reached its full capacity, it is possible that with a new mega battery pack it takes a few charging/discharging cycles to build up the full capacity.

If fully charged batteries empty faster than usual, they are probably used up. In such case have your batteries checked by your local dealer and exchanged, if necessary.

☞ If the v-max⁺ is at a standstill for some time, please connect it to the charger to retain the charge. This does not damage the sealed lead acid batteries, on the contrary, it increases their durability.

☞ If the mega battery pack is totally discharged, it takes a maximum of approximately 14 hours to recharge it.

The mega battery pack can be charged in any position. It is considered as safe as dry cells and admitted to air travel by DOT and IATA.

Always charge your battery pack with the AAT charger delivered with your v-max⁺. This particular charger automatically turns off when the batteries are fully charged keeping them from being overcharged.

8.3.1 Charging with the automatic charger

To charge the batteries you may leave the mega battery pack in its bag attached to the wheelchair. First pull the plug of the power cable then insert the plug of the charger entirely into the charging socket. Finally plug the charger into the wall outlet.

- ☞ Since the v-max+ is supposed to be connected to the charger at all times whenever it is not in use, you need to remove the charger from the wall outlet and pull the plug from the charging socket on the battery pack every time before you use it.
- ☞ Before charging, please read and follow all instructions and warning notes printed on the charger.
- ☞ Exclusively use the AAT Alber Antriebstechnik GmbH charger.
- ☞ Never touch the plug with moist hands!

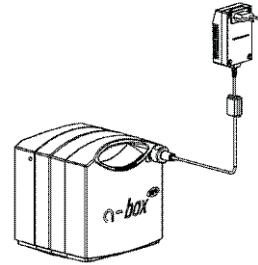

Signals of the charger

charger	LED orange	batteries are being charged
charger	LED green	batteries are fully charged, maintenance mode

8.3.2 Charging batteries in your vehicle

By means of the voltage voltage converter you may even charge your mega battery pack while driving your car.

First remove the power cable. Then fully insert the plug of the charger into the charging socket on the mega battery pack. Then connect the charger to the voltage voltage converter. Finally you plug the voltage converter into the cigarette lighter.

Afterwards you first pull the voltage converter's plug from the cigarette lighter before you disconnect it from the charger.

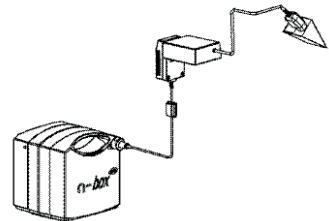

Signals of the charger and the voltage converter

charger	LED orange	batteries are being charged
charger	LED green	batteries are fully charged, maintenance mode
voltage converter	beeping	12 V supply is low

8.4 Fuse

The mega battery pack has two fuses, each 40A, located in a special compartment ❶.

If a change of fuses is necessary, put a pin in the opening ❷ on the side of the mega battery pack. This unlocks the drawer, so you can pull it out.

- ☞ You may not mend or by-pass a defect fuse. Always replace it with an identical one of the same amperage.
- ☞ AAT Alber Antriebstechnik GmbH could offer you replacements of the fuses.
- ☞ Before you exchange the fuses, please remove the charger from the mega battery pack!
- ☞ Should your fuses burn out frequently, please contact AAT Alber Antriebstechnik GmbH or your authorized dealer.

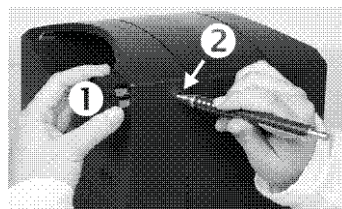

8.5 Cleaning

For cleaning the power unit, mega battery pack, grips and brackets of the v-max⁺ please merely use a mild household cleaner.

- ☞ Please keep in mind to clean the powered wheel with compressed air or with a dry brush regularly. It is possible that the powered wheel is excessive worn up because of contamination or deposits.
- ☞ Make sure that no water gets into the v-max⁺; therefore, merely use a damp cloth for cleaning.
- ☞ In the interest of your safety, do not use a high-pressure cleaning device.
- ☞ Please make sure that your wheelchair is cleaned according to the manufacturer's specifications.

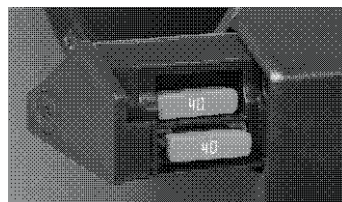

8.6 Recycling

Ihr v-max⁺ and its mega battery pack are products of long durability. However, if your v-max⁺ is old and has reached the end of its lifespan you may return its components to AAT Alber Antriebstechnik GmbH or your local dealer to be recycled.

A new law concerning electric and electronic devices (ElektroG) has been passed on March 24, 2005 regulating the taking back and recycling of old electric and electronic devices.

According to the Federal Office of Environment Protection (German BDU) the v-max⁺ is considered a means of transportation and does not fall under the law concerning the recycling of old electric or electronic devices (ElektroG, §2 paragraph 1 sentence 1 (cross reference, Guideline of the European Parliament 2002/96/EG).



9 Warranty and liability

9.1 Warranty

AAT Alber Antriebstechnik GmbH grants a warranty of two years for all its products of type v-max⁺ including all its accessory parts (with the exception of the sealed lead acid batteries). The warranty begins at the date of purchase and covers failure of material and errors in manufacturing.

For the sealed lead acid batteries, always assuming correct maintenance, AAT Alber Antriebstechnik GmbH grants a warranty of 6 months from the date of purchase.

The warranty becomes void concerning defects or damage which are the result of the following:

- damage due to excessive strain
- damage due to improper handling
- violent damage
- natural wear and tear such as toothed driving belt, toothed segments, wheelchair wheels, driveshaft
- improper and insufficient maintenance
- unauthorized constructional changes or inappropriate use of the device or its accessories
- using the v-max⁺ exceeding its maximum lifting capacity
- improper charging of the lead batteries

9.2 Liability

The manufacturer AAT Alber Antriebstechnik GmbH is neither liable nor responsible for potential damage of the v-max⁺ in case of:

- improper handling of the device
- repair, assembly or other work performed on the movilino by unauthorized persons
- operation not in accordance with this user's manual
- extraneous parts added or connected to the v-max⁺
- parts removed from the v-max⁺
- operation exceeding the maximum lifting capacity
- no regular biannual maintenance check performed by AAT Alber Antriebstechnik GmbH or its authorized personnel
- operation of the v-max⁺ with insufficiently charged batteries.



Ideen bewegen mehr

v-max⁺



Ideen bewegen mehr

v-max⁺



Ideen bewegen mehr

AAT Alber Antriebstechnik GmbH

Postfach 10 05 60 · D-72426 Albstadt
Tel.: 0 74 31 - 12 95 0 · Fax.: 0 74 31 - 12 95 35
Email: info@aat-online.de · www.aat-online.de